

iHome®

Model iD99
**Dual Dock Dual Alarm
Stereo System for
iPad®, iPhone® or iPod®**



Note: Apps are not covered in detail in this booklet. To learn more about how apps can enhance your experience, please visit the App Store.

Questions? For latest instructions, visit www.ihomeaudio.com/support

Table of Contents

Controls and Indicators / Display.....	1
Quick Start.....	2
Setting Up the Unit	3
Using the Alarms	4
Listening to iPad/iPhone/iPod / Listening to Radio.....	5
Using the Unit in Other Countries / Listening to other portable audio devices / Sleep Operation	6
Nap Operation / Dimmer Operation / USB Charging / Replacing Clock Backup Battery	7
A Consumer Guide to Product Safety	8
Trouble Shooting	9
Warranty Information	11

FCC Information

This device complies with Part 15 of the FCC Rules, operation is subject to the following two conditions: (1) This device may not cause harmful interference, and (2) this device must accept any interference received, including interference that may cause undesired operation.

- Warning: Changes or modifications to this unit not expressly approved by the party responsible for compliance could void the user's authority to operate the equipment.
- NOTE: This equipment has been tested and found to comply with the limits for a Class B digital device, pursuant to Part 15 of the FCC Rules.

These limits are designed to provide reasonable protection against harmful interference in a residential installation. This equipment generates, uses and can radiate radio frequency energy and, if not installed and used in accordance with the instructions, may cause harmful interference to radio communications.

However, there is no guarantee that interference will not occur in a particular installation. If this equipment does cause harmful interference to radio or television reception, which can be determined by turning the equipment off and on, the user is encouraged to try to correct the interference by one or more of the following measures:

- Reorient or relocate the receiving antenna.
- Increase the separation between the equipment and receiver.
- Connect the equipment into an outlet on a circuit different from that to which the receiver is connected.
- Consult the dealer or an experienced radio/TV technician for help.

This Class B digital apparatus complies with Canadian ICES-003.

Cet appareil numérique de la classe B est conforme à la norme NMB-003 du Canada.

Maintenance

- Place the unit on a level surface away from sources of direct sunlight or excessive heat.
- Protect your furniture when placing your unit on a natural wood and lacquered finish. A cloth or other protective material should be placed between it and the furniture.
- Clean your unit with a soft cloth moistened only with mild soap and water. Stronger cleaning agents, such as Benzene, thinner or similar materials can damage the surface of the unit.

Controls and Indicators

Top Panel

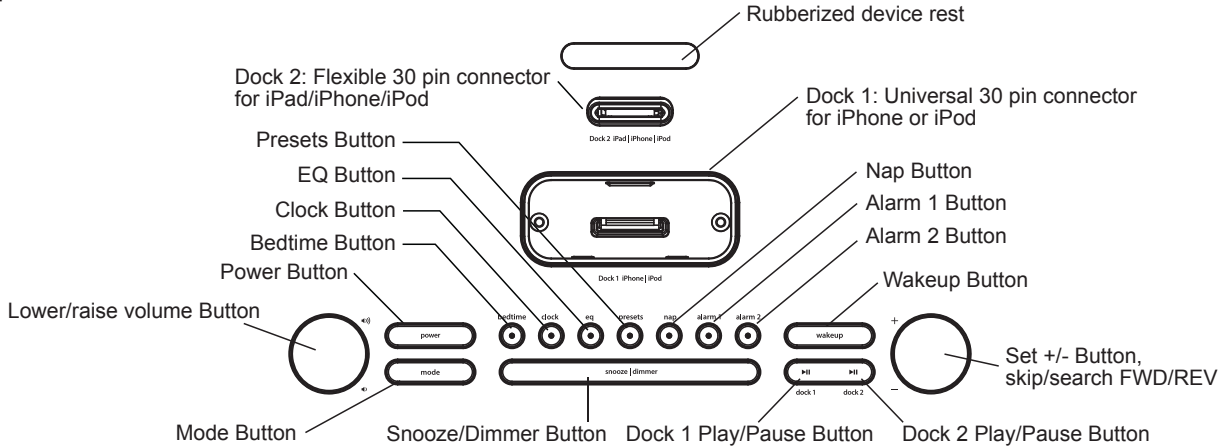

Rear Panel

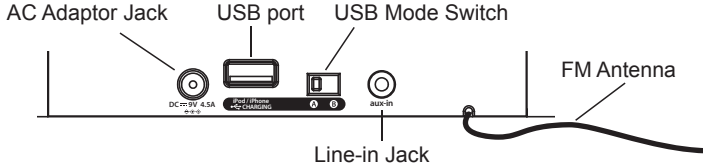

Bottom Panel

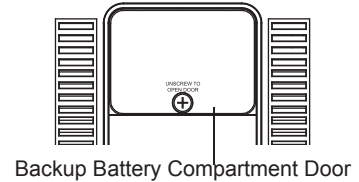

Display

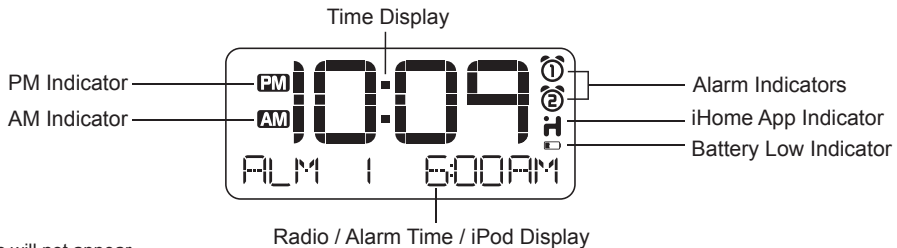

NOTE: AM/PM indicators will not appear when clock is set to 24 hour display mode

quick start

1: power

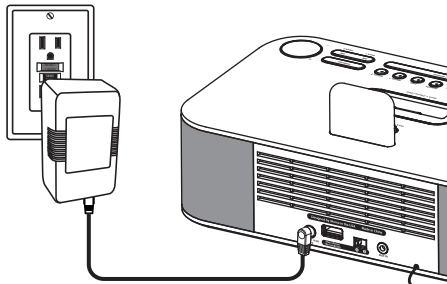

Attach AC adaptor cable to DC jack on back of the unit and plug the other end into a wall socket. Remove pull tab from the backup battery compartment on the bottom of the unit.

2: docking your iPad/iPhone/iPod

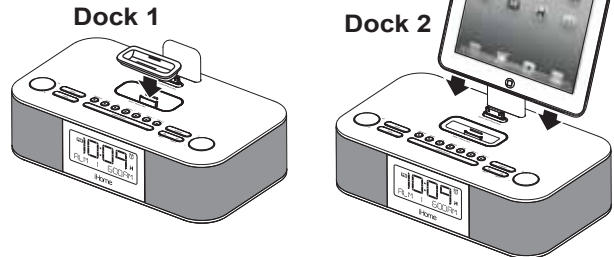

Dock 1: Select the insert for your iPhone or iPod and place in Dock 1. Gently dock your iPhone or iPod. You can safely dock your iPhone or iPod without an insert provided you use care.

Dock 2: Gently dock your iPad, iPhone or iPod onto the flexible 30 pin dock on Dock 2. The devices docked in Dock 1 and Dock 2 will charge while docked. Press the **Dock 1 ▶II** or **Dock 2 ▶II Button** on the unit to play your iPad, iPhone or iPod.

NOTE: Inserts provide the best stability for your iPhone or iPod. If you do not have an insert for your iPhone/iPod, you can safely dock it provided you always do so gently and carefully. To purchase an insert visit www.ihomeaudio.com or call iHome toll free at 1-877-446-6301 to purchase one.

Use this insert

iPod touch 2G
insert 16

iPhone 4
insert 19

nano 6G/touch 4G
insert 20

For this iPhone / iPod

iPod touch 2G/3G

iPhone 4

nano 6G
iPod touch 4G

3: Setting Clock with AutoSync



Dock your iPad, iPhone or iPod (see step 2). The unit will attempt to autosync to the time on your iPad, iPhone or iPod. This process takes about 3 seconds.

4: Radio

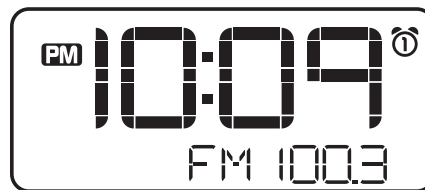

Press and release the **Mode Button** as needed to select FM band. Press and release the **+ or - Button** to tune in a station. See page 5 for programming presets.

Setting Up the Unit

Connecting the Unit to Power Source

Connect the AC adaptor cable plug into the DC jack on the back of the system, then plug the AC cord of the AC adaptor into the wall outlet. Adaptor must be plugged in to operate unit. **The unit does not operate on battery** (a battery back up system maintains clock settings during power failures).

Updating your iD99 firmware

For best performance, make sure to update the iD99 firmware. To do so, download the free **iHome Set** app from the App Store. Launch the app, scroll to “Search for Update”, then follow directions to update the firmware.

Note: Please use Dock 2 for firmware update.

Turning the Unit ON or OFF

Press the **Power Button** on the unit at any time to turn the unit On or Off. Note that a docked iPad, iPhone or iPod will continue to charge when the unit is turned off as long as the AC adaptor is plugged in.

Setting the Clock Time Using AutoSync

The AutoSync feature automatically syncs the time setting on the unit to the time on your iPad, iPhone or recent model iPod (iPod touch, iPod nano and iPod Classic; older iPod models such as iPod mini do not support this feature).

AUTOSYNC SETTING

By default, the unit is set to AUTOSYNC ON mode and will attempt to autosync the time whenever a capable iPhone or iPod is docked in Dock 1 OR an iPad, iPhone or iPod is docked in Dock 2.

1. Dock your iPad, iPhone or recent model iPod in the unit. In about 3 seconds, the unit will sync to your device.
2. The unit will now autosync every time a capable iPhone/iPod or iPad is docked.

NOTE: iPhone time is automatically updated to the correct time via cell phone towers. The time on your iPad or iPod is accurate only to the time on the computer the last time the iPad/iPod was synced to it. It's possible to have up to 59 seconds difference between the unit and synced iPad/iPhone/iPod.

To adjust autosync settings: Press and hold the **Clock Button** located on the top of the unit for 2 seconds. “AUTOSYNC ON” flashes on the display and a beep sounds. To turn autosync off, press and release the **+ or - Button** while AUTOSYNC ON is flashing until “AUTOSYNC OFF” appears. This will disable autosync and allow you to set the time manually (see below).

Setting Time and Calendar Manually

Autosync must be OFF to set the clock manually.

1. Press and hold the **Clock Button** located on the top of the unit until “AUTOSYNC ON” or “AUTOSYNC OFF” flashes on the display,(if AUTOSYNC ON appears, press the **+ or - Button** to toggle to AUTOSYNC OFF setting).
2. Press and release the **Clock Button**. The time display will flash. Press the **+ or - Button** to adjust the time (hold for a few seconds to advance or reverse rapidly). Remember to set the correct AM or PM hour. An icon in the upper left hand corner of the time display indicates AM or PM.
(Note: if you wish to change the time display from the 12-hour format to the 24-hour format, sometimes called ‘military time’, press and release either the **Alarm 1 Button** or **Alarm 2 Button** to switch between 12-hour and 24-hour display formats.)
3. Press and release the **Clock Button** again. The year will flash in the lower part of the display. Press and release the **+ or - Button** until the current year is displayed.
4. Press and release the **Clock Button** again. The month and date will flash. Press and release the **+ or - Button** until the current month and date is displayed.
5. Press and release the **Clock Button** once more. Two beeps will sound to confirm your settings and you will exit Time and Calendar Setting mode.

Using the Alarms

This unit has a dual alarm system so you can set two separate alarms to different alarm times, wake-to sources and schedules (daily, weekdays or weekend). *Tip: Download the free iHome Set app for advanced alarm, snooze and sleep functions.*

Setting the Alarms

Note: Alarm 1 and Alarm 2 are set the same way; **Alarm Button** below means the button (**Alarm 1** or **Alarm 2**) for whichever alarm you are setting.

1. Press and hold the **Alarm 1** or **Alarm 2 Button** until the alarm time flashes on the lower part of the display. Press and release the **+** or **- Button** to set the alarm time (press and hold for faster setting). Remember to set the correct AM or PM time.
2. Press and release the **Alarm Button** again to confirm the set alarm time, then press and release the **+** or **- Button** to set the alarm schedule ('wake 7 days' = the whole week, 'wake weekday' = Monday through Friday, 'wake weekend' = Saturday and Sunday only).
3. Press and release the **Alarm Button** again, then press and release the **+** or **- Button** to select an alarm source to wake to: (Dock 1, Dock 2, Radio, or Buzzer).

For wake to Dock 1 or Dock 2: Select Dock 1 or Dock 2 to wake to a docked iPad, iPhone or iPod in Dock 1 or an iPhone or iPod in Dock 2. Once Dock 1 or Dock 2 is selected, press and release the **+** or **- Button** to select Normal (plays the last played song) or select Playlist to wake to a custom playlist. **NOTE:** you must create a playlist named "iHome" in iTunes and have it on your iPad/iPod/iPhone. The unit will play music randomly from within the "iHome" playlist. If no playlist is detected the unit will play the last song played instead. If the unit does not detect an iPad/iPhone/iPod at the set alarm time, the unit will default to buzzer alarm. The alarm cycle lasts for one hour; make sure you have enough music on your iPad, iPhone or iPod to last that long.

For wake to radio: after selecting Radio as the wake to source, press and release the **Alarm Button** and then press and release the **+** or **- Button** to select a radio station or press and release the **Presets Button** as needed to select a stored preset radio station to wake to (see *Listening to Radio* on page 5 for details on setting radio stations as presets).

4. Press and release the **Alarm Button** again, then press and release the **+** or **- Button** to set the alarm volume.
5. Press and release the **Alarm button** again (or no button within 10 seconds). Two beeps will confirm setting is complete and you will exit the alarm setting mode. The alarm will be armed once set and the corresponding alarm icon will light up. The lower part of the display will show the earliest set alarm time.

Reviewing, Arming and Disarming Alarm (Turn Alarm Function On and Off)

Alarms are automatically armed when set. Active alarms are indicated by alarm icons on the display.

1. Once an alarm is armed, the lower part of the display will show the alarm time. If more than one alarm is armed, the earliest alarm time will show.
2. To review the alarm time, press an alarm button once. The related alarm time and wake source will show on the lower part of the display.
3. During alarm review, press and release the Alarm Button once to toggle it on or off. If the alarm is armed, the related alarm icon will light up.

Resetting the Alarm to Come on the Next Day

1. When the alarm is sounding, press and release the **Power Button**, **Wakeup Button**, **Alarm 1** or **Alarm 2 Button** to stop the alarm and reset it to come on the next set day. For example, if alarm is set for weekdays and you reset the alarm on Friday, the alarm will come on again on Monday, not Saturday.

*TIP: When the iHome Sleep app is running, press the **wakeup button** to access wake profiles. When the app is not running, you can press the **wakeup button** to shut off the unit and reset the alarm to come on at the set time.*

Snooze

1. To program a custom snooze time, press and hold the **Snooze Button** during normal operation (when alarm is not sounding) until the snooze minutes display appears. Press and release the **+** or **- Button** to set the snooze time from 1 to 29 minutes. *TIP: You can also adjust snooze time with the iHome Set app.*
2. Press the **Snooze Button** after the alarm sounds. The alarm will be silenced and come on again 9 minutes later (or at the custom minute interval you set). Snooze can be pressed several times during the 1 hour alarm cycle.

Sure Alarm

The unit has a sure alarm feature so the buzzer alarm still sound in the event of a power failure if the backup battery is installed (see page 7). If your iPad/iPhone/iPod has no sound for 35 seconds or is not present, the unit will switch to buzzer alarm automatically.

Listening to iPad, iPhone or iPod

The unit has two docks, each with separate Play/Pause controls. Dock 1 is for iPhone or docking iPod models. Dock 2 is for all iPad, iPhone and docking iPod models. Inserts are provided for docking popular iPhone and iPod models in Dock 1. While inserts provide the best stability, you can safely dock your iPhone or iPod *without* an insert provided you always do so gently and carefully. If you prefer to use an insert and do not have one for your model, please contact customer service at 1-800-288-2792 to purchase one.

1. Dock an already playing iPad, iPhone or iPod. The unit will automatically turn on and you will hear the audio playing from your iPad/iPhone/iPod.

Note: If the audio source volume is too low on the iPad/iPhone/iPod, the unit may not detect that the iPad/iPhone/iPod is in play mode. If so, pressing the **Dock 1** or **Dock 2 ►|| Button** should make the device in the related dock play.

2. When the iPad/iPhone/iPod is docked and in standby mode, press the **►|| Button** on the unit to play the iPad/iPhone/iPod. If the unit is already on, press and release the **Mode Button** as needed until “DOCK 1” or “DOCK 2” appears on the lower part of the display, indicating the unit is controlling Dock 1 or Dock 2. If your iPad, iPhone or iPod touch is in video mode, you may see the “locked” slider on your iPad/iPhone/iPod display. If so, you will need to unlock your iPad/iPhone/iPod.

3. Press the **Dock 1** or **Dock 2 ►|| Button** on the unit to pause play in that dock; press again to resume play.
4. Press the **+** or **- Button** on the unit to go to the next or previous track. Press and hold while track is playing for high speed forward or reverse music search of the current track.

Adjusting Sound on the Unit

You can adjust the sound on the unit while listening to any sound source.

1. Press the **◀** or **▶) Button** on the unit to adjust the system volume.
2. Press and release the **EQ Button** as needed to select Treble, Bass, Balance or 3D sound effect, then press the **+** or **- Button** to adjust settings.

TIP: You can also adjust EQ with the iHome Set app.

Listening to Radio

Setting up the Antenna

Extend FM wire antenna fully for best reception. Do not strip, alter or attach to other antennas.

Tuning and Playing the Radio

1. Press and release the **Mode Button** as needed to turn on the unit and cycle through Dock 1, Dock 2, FM radio and Aux-in modes.
2. Once FM mode is selected, press the **+** or **- Button** to tune the radio to a desired station. The current radio frequency appears in the lower right of the display. Press the **+** or **- Button** for a few seconds to scan for the next clear station.

3. To memorize a station as a preset:
 - A. Press the **Presets Button** as needed to step through the 6 presets (P1 - P6) to the number you wish to assign, and then *hold* the **Presets Button** until the selected preset number begins flashing in the display.
 - B. Press the **+ or - Button** to tune the radio to a desired station. Hold briefly to have the radio autoscan/search for the next clear station.
 - C. Press the **Presets Button** to confirm the setting, two confirmation beeps will confirm the setting and the preset number you wish to assign. Repeat steps A-C to preset up to 6 stations.
4. To listen to a preset station at any time, press the **Presets Button** to choose the desired preset.
5. Press the **◀ or ▶) Button** on the unit to adjust the system volume.
6. Press the **Power Button** to turn off the unit.

Using the Unit in Other Countries

Different regions of the world use different FM radio frequency steps and ranges. You will need to select the one that matches the standards in your region (USA, EUROPE, JAPAN, AUSTRALIA, or CHINA). The default setting is USA; if you live in the US, you may skip this section.

1. Make sure the unit is OFF (not playing in any mode). Press and hold the **Mode Button** for about 5 seconds until “Radio xxx” appears in the lower part of display. Press and release the **+ or - Button** to set the “xxx” to your region.
2. Press and release the **Mode Button** again (or no button within 10 seconds) to exit the radio frequency setting mode. Two beeps will confirm radio frequency setting.

Listening to other portable audio devices

You can play an MP3 player or other portable audio device through the iD99 via the Aux-in Jack.

1. Plug one end of a stereo audio patch cord (**available at <http://www.ihomeaudio.com>**) into the headphone or line-out jack on your device and the other end of the patch cord into the iD99 Line-in Jack, located on the back of the unit.
2. Press and release the **Mode Button** as needed until “Aux-in” appears in the lower part of display, indicating Aux-in playing mode.
3. Turn on and play your device.
4. Press the **◀ or ▶) Button** on the unit to adjust the system volume. You may need to adjust your device volume, too.
5. Press the **Power Button** to turn off the unit. Remember to turn off your device, too.

Sleep Operation

Sleep mode lets you sleep to iPad/iPhone/iPod or the radio, gradually lowering the volume until the unit shuts off at the selected time.

1. Press the **Bedtime Button** to enter sleep mode. The Sleep Icon will appear on the display to indicate sleep mode. Sleep mode has a Gentle Sleep feature which gradually lowers the volume. The unit will automatically turn off after the selected sleep time.
2. You can adjust the sleep timer from 120, 90, 60, 30, 15 minutes or OFF by pressing the **Bedtime Button** again.
3. When the display changes back to show the real time, pressing the **Bedtime Button** once will show the sleep time remaining. Pressing it again will change sleep time to next lowest increment.
4. iD99 has independent volume setting for sleep mode so you can adjust the sleeping volume without affecting the alarm volume. Press the **◀ or ▶) Button** on the unit to adjust the system sleep volume. The sleep volume will remain at that level the next time you enter sleep mode until controls are changed.
5. To stop listening at any time, press the **Power Button** on the unit to turn it off.

Nap Operation

Nap mode lets you set an alarm separate from the Alarm 1 and Alarm 2 settings. The nap wake to source by default is the buzzer alarm.

1. Press the **Nap Button** located on the top of the unit as needed to adjust the nap timer for 5, 10, 15, 20, 30, 45, 60, 90 or 120 minutes or OFF.
2. The nap time remaining will appear on the display as the time diminishes. Pressing the **Nap Button** again will change nap time to the next highest setting.

Dimmer Operation

During normal operation, press the **Snooze/Dimmer Button** to control the brightness of the LCD display.

USB Charging

The unit has a USB charging port located on the back of the unit.

1. To charge your device, connect one end of a USB charging cable (not included) into the USB charging port on the unit and the other to your device's charging port.
2. Monitor the charging status on your device. If it does not appear to be charging, try moving the USB Mode Switch on the unit to the other position.

NOTE: While the USB port should charge the majority of devices, some makers use proprietary standards and their devices may not charge. If this occurs, use the charger that came with the device.

Replacing Clock Back-up Battery

The unit comes with 1 CR2450 back-up battery installed to provide continuous alarm operation and clock settings in the event of a power failure. **Remove the battery pull tab before use.** When the Battery Low Icon located on the lower right of the display is flashing, it is time to replace the back-up battery. The battery compartment is located on the bottom of the unit.

1. Please make sure the AC adaptor is connected, otherwise all settings may be lost during battery replacement.
2. Use a Phillips screwdriver to remove the battery compartment cover located on the bottom of the unit. Remove the exhausted battery.
3. Insert 1 CR2450 battery checking that the + side is facing you. Replace the compartment door.

Note: Make sure you dispose of battery properly (see your local regulations).

Replacing Backup Battery

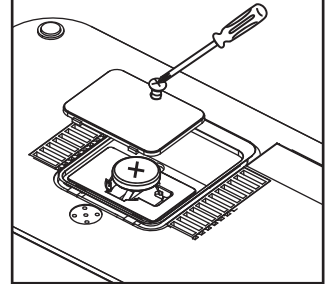

WARNING: Lithium batteries can explode or cause burns if disassembled, shorted, recharged, exposed to water, fire, or high temperatures. Do not place loose batteries in a pocket, purse, or other container containing metal objects, mix with used or other battery types, or store with hazardous or combustible materials. Store in cool, dry, ventilated area. Follow applicable laws and regulations for transport and disposal.

IMPORTANT SAFETY INSTRUCTIONS

When used in the directed manner, this unit has been designed and manufactured to ensure your personal safety. However, improper use can result in potential electrical shock or fire hazards. Please read all safety and operating instructions carefully before installation and use, and keep these instructions handy for future reference. Take special note of all warnings listed in these instructions and on the unit.

1. **Water and Moisture** – The unit should not be used near water. For example: near a bathtub, washbowl, kitchen sink, laundry tub, swimming pool or in a wet basement.
2. **Ventilation** – The unit should be situated so that its location or position does not interfere with its proper ventilation. For example, it should not be situated on a bed, sofa, rug or similar surface that may block ventilation openings. Also, it should not be placed in a built-in installation, such as a bookcase or cabinet, which may impede the flow of air through the ventilation openings.
3. **Heat** – The unit should be situated away from heat sources such as radiators, heat registers, stoves or other appliances (including amplifiers) that produce heat.
4. **Power Sources** – The unit should be connected to a power supply only of the type described in the operating instructions or as marked on the appliance.
5. **Power-Cable Protection** – Power supply cables should be routed so that they are not likely to be walked on or pinched by items placed upon or against them. It is always best to have a clear area from where the cable exits the unit to where it is plugged into an AC socket.
6. **Cleaning** – The unit should be cleaned only as recommended. See the Maintenance section of this manual for cleaning instructions.
7. **Objects and Liquid Entry** – Care should be taken so that objects do not fall and liquids are not spilled into any openings or vents located on the product.
8. **Attachments** – Do not use attachments not recommended by the product manufacturer.
9. **Lightning and Power Surge Protection** – Unplug the unit from the wall socket and disconnect the antenna or cable system during a lightning storm or when it is left unattended and unused for long periods of time. This will prevent damage to the product due to lightning and power-line surges.
10. **Overloading** – Do not overload wall sockets, extension cords, or integral convenience receptacles as this can result in a risk of fire or electric shock.
11. **Damage Requiring Service** – The unit should be serviced by qualified service personnel when:
 - A. the power supply cable or plug has been damaged.
 - B. objects have fallen into or liquid has been spilled into the enclosure.
 - C. the unit has been exposed to rain.
 - D. the unit has been dropped or the enclosure damaged.
 - E. the unit exhibits a marked change in performance or does not operate normally.
12. **Antenna** – Do not connect an external antenna to the unit (other than that provided).
13. **Periods of Nonuse** – If the unit is to be left unused for an extended period of time, such as a month or longer, the power cable should be unplugged from the unit to prevent damage or corrosion.
14. **Servicing** – The user should not attempt to service the unit beyond those methods described in the user's operating instructions. Service methods not covered in the operating instructions should be referred to qualified service personnel.

**Questions? Visit www.ihomeaudio.com
or call 1-877-446-6301 Toll Free**

Troubleshooting

Symptom	Possible Problem	Solution
Unit does not turn on	AC adaptor isn't plugged into a working wall socket or not plugged into the power supply jack on back of the unit	Plug the AC adaptor into a working wall socket and plug the connector into the supply jack on the unit
Unit doesn't respond	Unit requires a reset	If unit is plugged in and doesn't respond, try resetting the unit by following these steps: a) remove iPad/iPhone/iPod from dock b) unplug unit from power source c) remove back up battery d) wait a few minutes, then restore battery and resume use
	iPad/iPhone/iPod is not docked properly	Remove your iPad/iPhone/iPod from the dock and check for obstruction on the connectors in the dock and on your iPad/iPhone/iPod. Then reseat it in the dock.
Battery Low icon always flashing	Battery is weak	Replace with new battery
	Battery was not installed properly	Check to make sure the + side is facing outwards
iPad/iPhone/iPod does not respond to the unit, iPad/iPhone/iPod is playing but no sound comes out	iPad/iPhone/iPod is not docked properly	Remove your iPad/iPhone/iPod from the dock and check for obstruction on the connectors in the dock and on your iPad/iPhone/iPod. Then reseat it in the dock.
	Your iPad/iPhone/iPod software is too old	Upgrade software on your iPad/iPhone/iPod via iTunes on your computer
	iPad/iPhone/iPod is locked up/plays but no sound comes out	Check the volume setting. Make sure your iPad/iPhone/iPod is working properly before docking into the unit. Please refer to your iPad/iPhone/iPod manual for details. See above for software upgrade information. You may need to reset your iPad/iPhone/iPod. Refer to your iPad, iPhone or iPod user guide for details on how to perform a reset.
	Using 1 st or 2 nd generation iPod, iPod Shuffle or other devices.	Unit cannot control those iPod models or other devices.
Unit/iPad/iPhone/iPod performance is erratic	The unit is reacting to external interference	Move unit away from potential sources of external interference such as computers, modems, wireless devices (routers) or fluorescent light.
No sound from unit	Volume is set too low on unit	Make sure volume is turned up
iPad/iPhone/iPod didn't charge up	iPad/iPhone/iPod is not docked properly	Remove your iPad/iPhone/iPod from the dock and check for obstruction on the connectors in the dock and on your iPad/iPhone/iPod. Then reseat it in the dock.
	iPad/iPhone/iPod is locked up/ frozen	Please make sure your iPad/iPhone/iPod is working properly before docking into the unit. Please refer to your iPad/iPhone/iPod manual for details.
	iPad/iPhone/iPod battery has problem	
Time sync didn't work	Older iPod models such as iPod mini do not support time sync function	Make sure you are using an iPhone or newer iPod such as touch, nano or classic. If not available, set time manually (see page 3).

Troubleshooting

Symptom	Possible Problem	Solution
Sound is distorted	Volume level is set too high	Decrease the volume
	Sound source is distorted	If the iPad/iPhone/iPod original sound source (MP3) is old or of poor quality, distortion and noise are easily noticed with high-power speakers. Try a different file from a trusted source such as iTunes.
		If you are using an external sound source try reducing the output volume on the device itself. Also try turning bass boost OFF.
EQ settings are too high.	Lower EQ settings.	
Unit/adaptor gets warm after extended play at high volume	This is normal	Turn unit off for awhile or lower volume
Snooze time is too long/short	Custom snooze time not set	Press and hold Snooze button then press + or - Button to adjust
Alarm not working	AM/PM time/alarm time not set correctly	When setting clock or alarm time, take note of the AM/PM indicators
	Alarm time or source selected for alarm 2 , not alarm 1 or vice versa	Make sure to set the alarm time and source for the alarm icon 1 or 2 that is shown on the clock display
	Wake schedule setting is not correct	7 days is every day alarm, weekday is Mon-Fri, and weekend is Sat-Sun. See page 4 for setting alarms.
	Calendar is not set correctly, which can affect wake schedule alarm operation	See page 3 for setting Clock/Calendar Section.
USB charging doesn't work	Device may not be connected properly or may require special circuit	Check that your USB cable is the correct kind for your device and that it is correctly connected to the unit and to your device. Try switching the US'B Mode Switch from the A or B position to its opposite. If this fails, use the charger that came with your device.

Limited 1 Year Warranty Information

iHome Products, a division of SDI Technologies Inc. (hereafter referred to as SDI Technologies), warrants this product to be free from defects in workmanship and materials, under normal use and conditions, for a period of 1 Year from the date of original purchase.

Should this product fail to function in a satisfactory manner, it is best to first return it to the store where it was originally purchased. Should this fail to resolve the matter and service still be required by reason of any defect or malfunction during the warranty period, SDI Technologies will repair or, at its discretion, replace this product without charge (except for a \$25.00 charge for handling, packing, return UPS/postage, and insurance). This decision is subject to verification of the defect or malfunction upon delivery of this product to the Factory Service Center listed below. The product must include proof of purchase, including date of purchase. The fee for service without proof of purchase is \$60.00.

Before returning this product for service, please first replace the batteries (if applicable) with fresh ones, as exhausted or defective batteries are the most common cause of problems encountered.

If service is still required:

1. Remove the batteries (if applicable) and pack the unit in a well padded, heavy corrugated box.
2. Enclose a photocopy of your sales receipt, credit card statement, or other proof of the date of purchase, if within the warranty period.
3. Enclose a check or money order payable to the order of SDI Technologies, for the sum of \$25.00 (\$60.00 without proof of purchase).
4. Send the unit prepaid and insured, to the Factory Service Center listed below.

**Consumer Repair Department
SDI Technologies Inc.
1330 Goodyear Drive
El Paso, TX 79936-6420**

Disclaimer of Warranty

NOTE: This warranty is valid only if the product is used for the purpose for which it was designed. It does not cover (i) products which have been damaged by negligence or willful actions, misuse or accident, or which have been modified or repaired by unauthorized persons; (ii) cracked or broken cabinets, or units damaged by excessive heat; (iii) damage to digital media players, CD's or tape cassettes (if applicable); (iv) the cost of shipping this product to the Factory Service Center and its return to the owner.

This warranty is valid only in the United States of America and does not extend to owners of the product other than to the original purchaser. In no event will SDI Technologies or any of its affiliates, contractors, resellers, their officers, directors, shareholders, members or agents be liable to you or any third party for any consequential or incidental damages, any lost profits, actual, exemplary or punitive damages. (Some states do not allow limitations on implied warranties or exclusion of consequential damages, so these restrictions may not apply to you.) This warranty gives you specific legal rights, and you may also have other rights which vary from state to state.

Your acknowledgement and agreement to fully and completely abide by the above mentioned disclaimer of warranty is contractually binding to you upon your transfer of currency (money order, cashier's check, or credit card) for purchase of your SDI Technologies product.

© 2011 SDI Technologies, Inc. All rights reserved

**Questions? Visit www.ihomeaudio.com
or call 1-877-446-6301 Toll Free**